

MULTIPLUS

INSTALLATION & USER GUIDE

CONTENTS

PRODUCT SUPPORT	1
READ THIS FIRST	2
MULTI PLUS SETUP	2
MANUAL MODE USER INSTRUCTIONS	4
WIRING INFORMATION	5
OPERATING MODE COLOURS	6

PRODUCT SUPPORT & INFORMATION

For further information or technical assistance please feel free to contact our Customer Service Department on:

Phone: +61 3 9793 2299

Email: info@spaelectrics.com.au

Web: www.spaelectrics.com.au

MULTI PLUS SETUP

READ THIS FIRST

The MULTI-PLUS light has 5 inbuilt modes of operation for use on a variety of different control systems or installation types.

When you first install your MULTI-PLUS light it will operate in the default, 'Manual' mode for use with a wall switch. In order to connect the light to a 3rd party pool controller OR change to a different operating mode please follow the below steps.

STEP 1 - POOL CONTROLLER SETUP

If connecting to a pool controller, please ensure the system is fully installed and you have completed all the relevant steps in the controller setup menu to operate the lights correctly.

During pool controller setup you will be prompted to select which light model is installed. Please use the below table to select the appropriate light for your pool controller type.

[For more information on this please refer to the pool controller installation manual].

POOL CONTROLLER	SELECT LIGHT MODEL
Astral Connect 10 [2016 to current]	SLX Light
Jandy Aqualink RS [F/W Rev. 'R' - Current]	Intellibrite Light
Zodiac Aqualink TRI	Intellibrite Light
Pentair EasyTouch	Intellibrite Light
Pentair IntelliTouch	Intellibrite Light

iRIS Setup
If installing the MULTI PLUS with an **iRIS** remote, please see the **iRIS** installation manual for 'Quick Setup' procedure.

NOTE: Some older pool controllers may not support these models. Please contact the controller manufacturer for upgrade assistance.

STEP 2 - LIGHT SETUP

IMPORTANT: Ensure Lights have been off for **30 seconds** prior to performing this step.

NOTE: This step can either be performed via a wall switch OR via the controller panel/Mobile App.

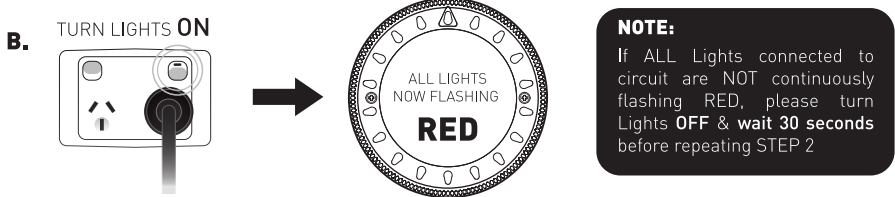
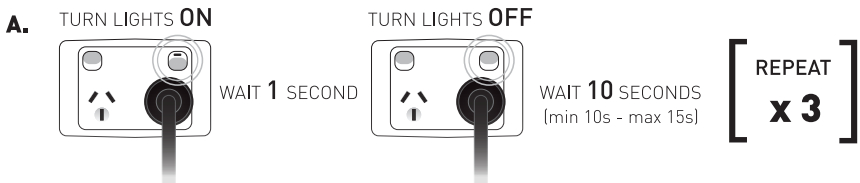

Continue to STEP 3

MULTI PLUS SETUP cont.

STEP 3 - SELECTING OPERATING MODE

After accessing SETUP MODE (STEP 2) the lights will **FLASH RED** continuously. This is MODE 1 (Manual mode)

Use the below process to change the operating mode to correspond to the required controller or operating type below.

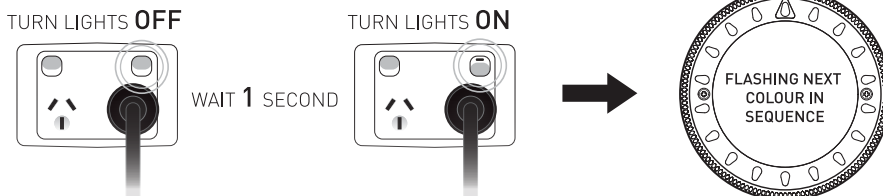

IMPORTANT: Once desired mode is reached (i.e. "Flashing Green - iRIS Mode) leave power turned ON and continue to STEP 4

'FLASHING' COLOUR	CONTROLLER / OPERATING TYPE	LIGHT MODEL SELECTED*
1. RED	Manual Mode (wall switch)	-
2. GREEN	Spa Electrics iRIS Controller	-
3. MAGENTA	Astral Connect 10 (2016 to current)	SLX Light
4. WHITE	Jandy Aqualink RS (F/W Rev. 'R'-Current)	Intellibrite Light
	Zodiac Aqualink TRI	Intellibrite Light
	Pentair EasyTouch	Intellibrite Light
	Pentair IntelliTouch	Intellibrite Light
5. BLUE	Standard MULTI Mode* (wall switch)	-

Continue to STEP 4

*Light Model Selected:

This indicates the model of light to be selected in the Pool Controller setup menu. Refer to STEP 1 of this manual for more information or please contact Spa Electrics. (03) 9793 2299

*Standard MULTI Mode:

This mode allows the MULTI PLUS light to operate in the standard Spa Electrics MULTI-Colour mode. This mode should only be used when operating a MULTI PLUS from a wall switch or RM-2 in conjunction with a standard Spa Electrics MULTI-Colour light. For more information please contact Spa Electrics. (03) 9793 2299

MULTI PLUS SETUP cont.

STEP 4 - SAVING OPERATING MODE

Once the desired operating mode is selected follow these steps to save the selection.

TURN SYSTEM **OFF**

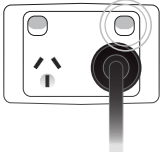

WAIT **30 SECONDS**

TURN SYSTEM **ON**

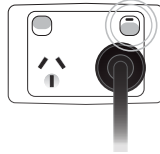

Important

You must wait at least **30** Seconds prior to turning the system back **ON** or selection process will fail and setup will need to be restarted.

STEP 5 - CONFIRM OPERATION

Your setup should now be complete. To confirm the system is working correctly, select a colour via the controller or wall switch (depending on operating mode selected) and check to ensure all lights are synchronised and the correct colour is displayed.

Refer to pg. 6 for available colours.

MANUAL MODE USER INSTRUCTIONS

OPERATING INSTRUCTIONS

1. To change the color of the light, simply turn your light **OFF** for **2** seconds and then turn it back **ON**. This will signal the light to proceed to the next colour in sequence.
To select a desired colour, simply step through the colours until you find your desired selection.

Refer to pg. 6 for available colours.

2. Your lights will automatically save your selected colour once the power has been turned **OFF** for more than **1** minute. So the next time the lights are used, they will illuminate on the last colour operated.
3. To reset or '**synchronize**' your lights; with the power turned **ON**, turn the power **OFF/ON** once rapidly. This will **RESET** your lights to **WHITE**

SYNCHRONIZED INSTALLATION

When installing multiple lights, to ensure synchronization and ease of operation ALL Lights must operate from a single switch.

WIRING INFORMATION

MANUAL MODE OPERATION (SYNCHRONISED POOL & SPA)

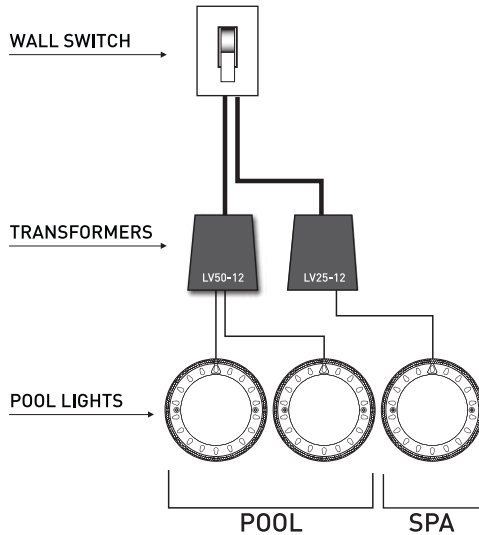

SYNCHRONIZED INSTALLATION

When installing multiple lights, to ensure synchronization and ease of operation ALL Lights must operate from a single switch.

CONNECTING TO POOL/LIGHTING CONTROLLER

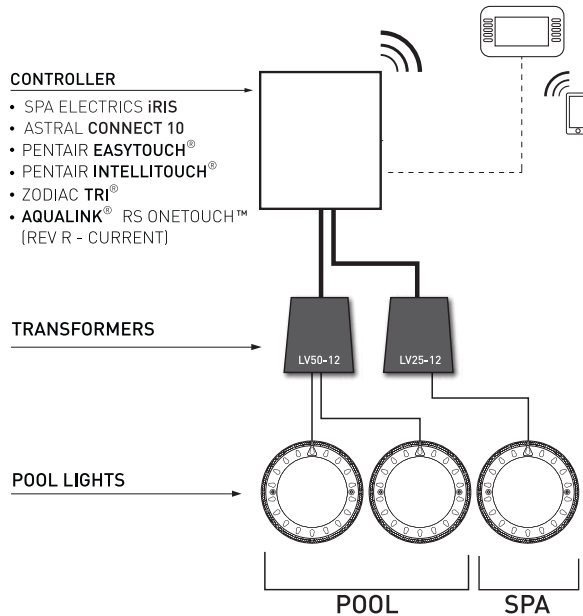

OPERATING MODE COLOURS

MANUAL MODE

1	WHITE 4000K
2	AQUA
3	BLUE
4	MAGENTA
5	RED
6	LIME
7	GREEN
8	OCEANIC VIEWS
9	TRANSCENDENCE
10	OUTBACK AUSTRALIA
11	SPRING EQUINOX

iRIS MODE

1	WHITE 4000K
2	AQUA
3	BLUE
4	MAGENTA
5	RED
6	LIME
7	GREEN
8	OCEANIC VIEWS
9	TRANSCENDENCE
10	OUTBACK AUSTRALIA
11	SPRING EQUINOX

CONNECT 10 MODE

1	BLUE
2	MAGENTA
3	RED
4	ORANGE
5	GREEN
6	AQUA
7	WHITE 4000k
8	CUSTOMISED COLOUR
9	RAINBOW PATTERN
10	OCEAN PATTERN
11	DISCO PATTERN

INTELLIBRITE MODE

1	SAM
2	PARTY
3	ROMANCE
4	CARIBBEAN
5	AMERICAN
6	CALIFORNIA SUNSET
7	ROYAL
8	BLUE
9	GREEN
10	RED
11	WHITE 4000k
12	MAGENTA

STANDARD MULTI* MODE

1	BLUE
2	MAGENTA
3	RED
4	LIME
5	GREEN
6	AQUA
7	WHITE 1
8	WHITE 2
9	SLOW COLOUR BLEND
10	FAST COLOUR CHANGE

*Standard MULTI Mode:

This mode allows the MULTI PLUS light to operate in the standard Spa Electrics MULTI-Colour mode. This mode should only be used when operating a MULTI PLUS from a wall switch or RM-2 in conjunction with a standard Spa Electrics MULTI-Colour light. For more information please contact Spa Electrics. (03) 9793 2299



© COPYRIGHT 2016 SPA ELECTRICS PTY. LTD.
ALL RIGHTS RESERVED

20160829